

Tz6 tűzzománc kemence



TZ6

Kemence 1 év garanciával.

Ár: 225 000 Ft.

www.fusing.hu

hobbytechnika@t-online.hu

Tel: 0634 340914, 06205 949442

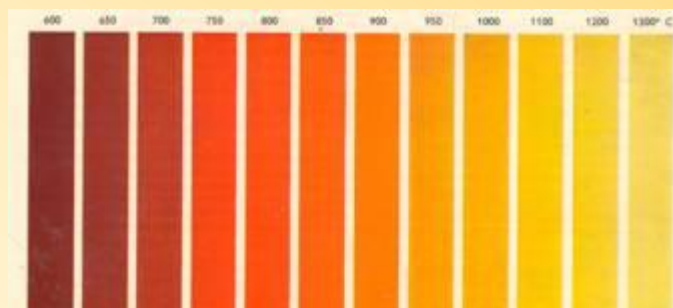

Kemence leírása

- Az elektromos tűzzománc kemence alkalmas:
 - **tűzzománcozásra, ezüst gyurma kiégetésére.**
 - A kemence 230 V hálózati feszültségről működik.
 - A kemence mobilizálható.
 - Maximális üzemi hőmérséklet: 1000 Celsius.
 - Teljesítmény 2100 Watt
 - A kemencéhez 16 A -es kismegszakítóval biztosított dugaszolóaljzat szükséges.
 - A kemence fém vázszerkezetű, hőálló festékkel kezelt lemezszeletrény.
 - A kemence hasznos beltere 110 mm magas, 190 mm széles és 280 mm mély.
 - Űrtartalom 6 liter. Súly: kb 45 kg
-
- A kemence ipari felhasználásra nem alkalmas.

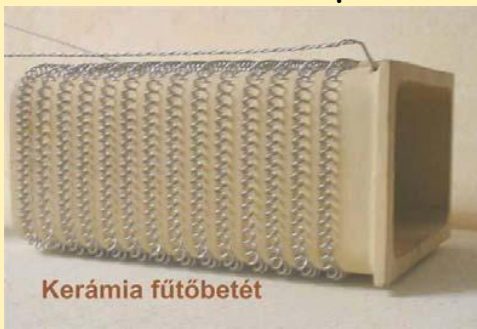

Kerámia fűtőbetét

A speciális, hőálló öntött kerámia fűtőbetét garantálja az egyenletes hő elosztást és a stabil üzemet.



Csatlakozási feltételek

FIGYELEM!

**A KEMENCE I. ÉRINTÉSVÉDELMI OSZTÁLYÚ KÉSZÜLÉK.
KIZÁRÓLAG VÉDŐVEZETŐVEL ELLÁTOTT HÁLÓZATI
ALJZATBA**

CSATLAKOZTASSUK AZ ELEKTROMOS KEMENCÉT.

**Fontos! Csatlakozás előtt a konnektor aljzat védővezető
folytonosságát feltétlenül villamos szakemberrel
ellenőriztetni kell!**

Javasoljuk, hogy a kemencéhez kiépített aljzat egy kapcsolóval
leválasztható legyen a hálózatról.

/A védővezető folytonosságáról legegyszerűbben egy
próbalámpával, vagy egy kézi műszerrel győződhetünk meg. A
fázisvezető és a védővezető között a hálózati feszültséget kell
tudni mérnünk, vagy a lámpa teljes fénnel világít./

**Figyelem: Bármilyen rendellenesség esetén kapcsolja le
a készüléket, vagy húzza ki a csatlakozó dugót.**

Meghibásodott készüléket csak szakember javíthat!

A gyártó kijelenti, hogy a kemence a vonatkozó elektromos
szabványoknak, előírásoknak megfelel.

Gyártó a változtatás mindenkori jogát fenntartja!

Tartozékok:

Berakóvilla, tüskés lemez 3 db, használati utasítás, garancialevél.



A kemence bekapcsolása

FIGYELEM! Bekapcsolás előtt ellenőrizni kell a hálózati kábel és csatlakozó dugaszolóaljzat sérülésmentességét.

Zárjuk be a kemence ajtaját.

A hálózati csatlakoztatás után a főkapcsolót bekapcsoljuk.

/FIGYELEM! A főkapcsoló bekapcsolása után a kemence szabályozója egy belső automatikus ellenőrzést végez. Ellenőrzi a hőérzékelő áramkör működését. Hiba esetén ez nem történik meg, a fűtés sem indítható el. A műszer hibakódot ír ki.

Ebben az esetben elsődlegesen mindig a túlfűtés érzékelő áramkört kell ellenőrizni. (gyakorlatban: szakadt –e a belső hőfokmérő áramköre?)

Ez megtörténhet elsődlegesen szemrevételezéssel./Pl: .elégett hőelem./

Ha, a bekapcsolási feltételek teljesülnek, a kemence üzembesz állapotba kerül. A beállított felfűtés elindul.

/Ha nyitott ajtónál is világít a sárga jelzőlámpa, meg kell nézni, hogy szabadon mozog –e a működtető rudazat a kemence oldalán. Szükség esetén utána állítás szükséges .Csak a hiba elhárítása után használható a kemence újra!/

Munka végeztével a működtetés kapcsolóval kapcsoljuk le a kemencét.

Kemence kezelőszervei

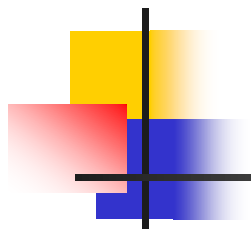

PV valós kemence hőfokérték
SV beállított hőfok

Funkció gomb

A h fok beállítása után a funkció gombbal nyugtázni kell a beállítást.

Számértékek le

Számértékek fel

Ajtókapcsoló visszajelzés

Fűtés lámpa

Ajtókapcsoló

Működtetés kapcsoló



Tűzzománcozás



Tartozék





Kezelés

Figyelem!

A kemence csak állandó felügyelet mellett használható. A műszer megfutásából, elégtelen működéséből eredő kárra a garancia nem terjed ki.

Bármilyen rendellenesség esetén válassza le a készüléket a hálózatról.

Célszerű a kemence elé gumi lábtörlőt helyezni.

Amennyiben a kemence szabadban van elhelyezve, esős, párás időben tilos használni!

Védőkesztyű használata ajánlott.

Kemence kezelése:

Nedves, párás helyen tárolt kemencét felfűtés előtt ki kell szárítani, majd fokozatosan szabad csak felfűteni.

A kemence ajtaját csak a szükséges ideig, a be és kirakodás idejére hagyjuk nyitva.

Kisebb hajszálrepedések a kemencetérben a kemence működését nem befolyásolják.

Szükség esetén a az ajtó forgó pontjait olajozni.

Garancia: 1 év, mely a gyártó telephelyén érvényesíthet .

Xmtg-608 Intelligence Dual Row 3-LED Display



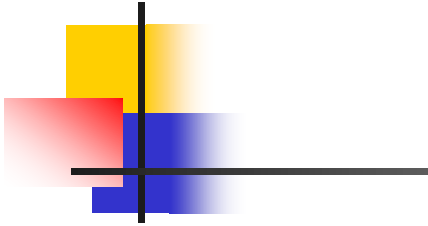

CE XMT*608 series Intelligent Temperature Controller

Operation Instruction



I、Survey

Thanks for your selection of our XMT*608 series intelligent temperature controller.

XMT*608 series intelligent temperature controller is double row 3-LED display, respectively display temperature measurement value (PV) and temperature set value (SV) under normal mode; When it is time temperature control, respectively display temperature measurement value (PV) and running time count down (SV), and also provide kinds of time control method selection; The controller can input kinds of signal which are used interchangeably, it adopts ON/OFF (P=0 时), PID control, allowing an easy parameter setting and convenient inputting, is widely used over temperature automatic control systems of machinery, chemical, ceramics, light industrial, metallurgy, petrification and heat treatment and so on.

II、Main technical indexes

1. Measurement deviation: $\pm 0.5F + S \pm 1$, additional cold end compensating deviation $\pm 1^{\circ}\text{C}$
2. Input (can be selected): CU50 (-50~150), PT100 (-80~600), K (-30~999), E (-30~700), J (-30~900), T (199~400)
3. Relay output (passive) contact capacity: AC250V 5A (resistance load)
period 2~120s can be adjusted.
4. Time range: 0~999s or 0~999m (can be selected)
5. Driving solid relay signal output: Driving electric current $> 15\text{mA}$ no-load voltage $> 12\text{V}$, period is about 2S.
6. Work power: 110V~242V, 50HZ Power consumption $< 3\text{W}$
7. Work environment: 0~50 $^{\circ}\text{C}$, relative humidity $\leq 85\%$, without corrode and strong electric radiation.

III、Controller panel

1、Controller panel (for reference)

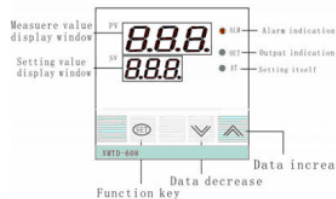

2、Connection (for reference)

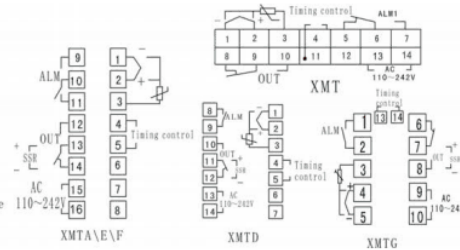

★Controller's specific connection should be confirm to the case's connection

IV、Meaning of the model code

XMT □—6 □ 8 □
1 2 3 4 5

1: the external dimension

- Blank:** 160×80×85 Installation hole 156×76
A: 96×96×80 Installation hole 92×92
D: 72×72×80 Installation hole 68×68

- E: 48×96×75 Installation hole 44×92
 F: 96×48×75 Installation hole 92×44
 G: 48×48×110 Installation hole 44×44
 S: 80×160×85 Installation hole 76×156
 B: 60×120×90 Installation hole 56×116
 L: Standard DIN35mm guide way installation
 C: 80×120×35 wall set installation

2: Operation display method: '6' 3-key gentle push-switch setting, double row 3-LED digital display, PID control.

3: Additional alarm:

'0' no alarm;

'1' upper limit alarm (**upper deviation alarm when it is time temperature control**)

4: Input: '8' input signal can interchange free (**no voltage and current input**)

5: Suffix Blank: relay output G: solid relay output T: Time control function

V、Inner parameter

Sheet 5-1

| Series | Attention | Name | Setting range | Description | Ex-factory |
|-------------|-----------|------|---|---|------------|
| First Menu | 0 | ★SP | Temperature Appointed Data | Determined by <i>d IL, d IH</i> Press▲ for 3s can modify the appointed value directly (Press▲ or ▼ for 3s to modify the appointed value under common temperature control) | Random |
| | 1 | ★tE | Timing setting | 0~999 Press▼ for 3s can directly modify appointed value | Random |
| Second menu | 2 | ◆RL | Upper limit alarm (temperature upper deviation alarm) | 0~100 The contact conversion output when exceeding alarm point, and alarm light is on (it used as temperature upper deviation alarm, when it is time temperature control , it makes sense till <i>Int=0</i>). | Random |
| | 3 | SE | Measurement deviation amendment | -20~20 Increasing or decreasing this data can modify Measurement value. | 0 |
| | 4 | P | Proportion band | 0 ~ 99.9 ~ 200 When P ↑ , proportion function ↓ , clash ↓ , but too little will add the heating time When P=0, the instrument is ON/OFF control. | 8 |
| | 5 | I | Integral time | 0~999 Set integral time so as to unchain residual Deflection caused by proportion control. To increase it, the static difference will be reduced, but when it is too high ,the static difference will drift instability. | 240 |

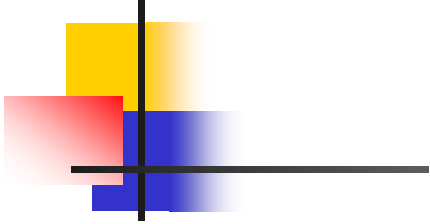

| | | | | | | |
|-------|----|-------------|-------------------------------|--|--|--------|
| | 6 | <i>d</i> | Differential time | 0~200 | Set differential time to avoid fluctuation of output so as to improve the steady of control. | 30 |
| | 7 | <i>t</i> | Control period | 2~ 120S | When it leaves factory, SSR is 2s; Relay is 10s. | 10 |
| | 8 | <i>HY</i> | Main control by drop in level | 0.1~50.0 | It makes sense when ON/OFF control. | 1.0 |
| | 9 | <i>RL</i> | Setting itself | <i>onoff</i> | <i>off</i> —close setting itself function ; <i>on</i> —turn on setting itself function. When choose <i>ON</i> , it will do setting itself for one time when the controller is under this working condition, and then automatically switch back <i>off</i> | 0 |
| | 10 | <i>Loc</i> | Lock | 0~50 | When <i>Loc</i> =0, can modify all the parameter; | 0 |
| Third | 11 | <i>Loc</i> | lock | 0~50 | When <i>Loc</i> =0, can modify all the parameter; | 0 |
| | 12 | <i>Sn</i> | Input | — | CUS0 (<i>L</i>), PT100 (<i>Pt</i>), K (<i>K</i>), E (<i>E</i>), J (<i>J</i>), T (<i>t</i>); | Random |
| | 13 | <i>dP</i> | Display Precision | 0~1 | <i>dP</i> =0, no decimal point, <i>dP</i> =1 have decimal point (this parameter will be inexistent when it is time temperature control) | 0 |
| | | <i>*LoL</i> | System function selection | 0~1 | <i>LoL</i> =0 heating control; <i>LoL</i> =1 cooling control | 0 |
| | 14 | <i>d ll</i> | Range lower limit | Starting point to <i>d IH</i> | — | Random |
| | 15 | <i>d IH</i> | Range upper limit | <i>d ll</i> to full range | | |
| | 16 | <i>*Int</i> | Time function selection | 0~3 (Time control side be switched on) | 0: common temperature control 1: start timing when it reaches the temperature , and the alarm relay output after reaching the time, the controller keep on heating; 2: start timing when it reaches the temperature , and the alarm relay output after reaching the time, the controller stop heating; | 0 |

| | | | | | |
|----|------------------|---------------------|-----|---|---|
| | | | | 3 : regular temperature control (no alarm) +time relay function: start timing when the power is on, alarm relay attracting after reaching the time . | 0 |
| 17 | ★uP _t | Time unit selection | 0~1 | 0: unit is second (S) 1: unit is minute (Min) | 0 |

Attention

Inner parameter sheet (Sheet5-1) ,the parameter with mark★ should be exit only when it with time control function .Common 608 temperature controller without this function; The parameter with mark◆ have different definition when it is under different control mode, details refer to explanation.

Flow chart:

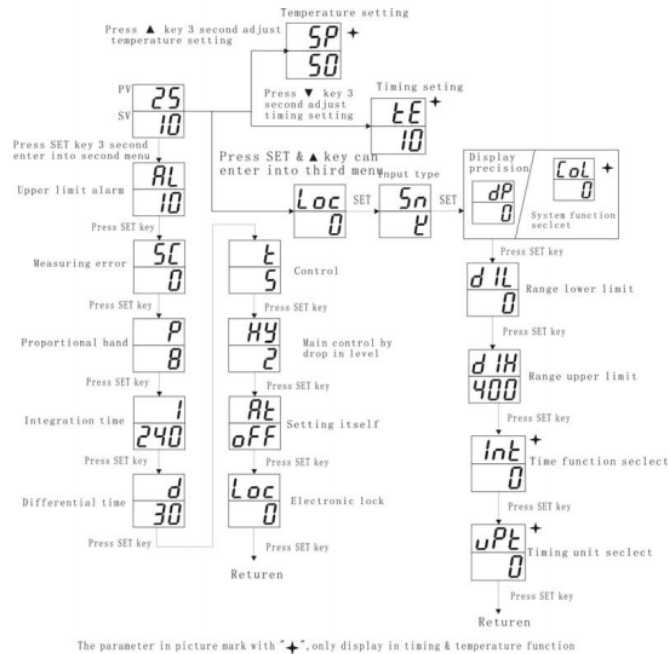

VI. Operation

- 1、 Make the controller link with power supply, sensor and control loop , and make the power on, the controller will start setting itself for 1S.
- 2、 After completing setting itself ,the controller will enter into normal measuring state, the upper row PV

window display measuring value ,the lower row SV window display set value.

3、 The first menu

A、 Time set value modification

Common temperature control mode: Press▲or▼for 3s to modify set value ,the upper row PV window display measurement value ,the lower row SV window display set value , press▲ or▼ to modify, long time to press can accelerate plus or minus. After modification, press SET to save and exit. If don't press any key, it will save and exit automatically after 10s.

Time control mode: Press▲for 3s to enter into temperature set value modification state ,the upper row PV window display parameter attention “5P”, the lower row SV window display parameter value, press▲ or ▼ to modify, long time to press can accelerate plus or minus. After modification, press SET to save and exit. If don't press any key, it will save and exit automatically after 10s.

★B、 Time set value modification (when it is time &temperature control)

Press▼for 3s to enter into time set value modification state, the upper row PV window display parameter attention “tE”, the lower row SV window display parameter value, press▲ or ▼to modify, long time to press can accelerate plus or minus. After modification, press SET to save and exit. If don't press any key, it will save and exit automatically after 10s.

Inner parameter setting (detailed refer to Sheet5—1)

(1) The second menu

Press SET for 3s to enter into the second menu, the upper row window display parameter code, the lower row window display parameter value, press▲ or ▼to modify, long time to press can accelerate plus or minus. After modification, press SET to save and exit. If don't press any key, it will save and exit automatically after 10s.

(2) The third menu

Press SET +▲to enter into the third menu, setting method is the same as above.

4、 Setting itself

First set the fixed value, and then enter the menu ,set *RL* to *ON*. At light is on, the controller enter into setting itself state, **set return difference about 0.5~1**, here the controller is ON/OFF control, after three times oscillation, new parameter *P. I. d* can be confirmed and saved, AT light goes out, the controller be reset and enter into the control state.

★6、 Time control function (when it is time& temperature control):

Cut time control side at any time, time will get back to the initial state: When getting time control side, the controller will run according to setting time count down.

Attention

When it is time& temperature control ,it provides multifarious time control method to select, time function detailed refer to inner parameter sheet (Sheet 5—1) ;*not* time function selection part. will not give unnecessary details here.

VII、 Fault Analysis and Clearance

XMT*608 adopt advanced production process, and have the strict test before leaving factory, it improve the reliability of the meter .The usual fault caused by the wrong operation or parameter setting .If you find the fault couldn't be cope with, please record it, and contact with the agent or us. Sheet 7-1 is the usual fault of XMT*608 in the daily application:

Sheet7-1 Common fault disposal

window display measuring value ,the lower row SV window display set value.

3、 The first menu

A、 Time set value modification

Common temperature control mode: Press▲or▼for 3s to modify set value ,the upper row PV window display measurement value ,the lower row SV window display set value , press▲ or▼ to modify , long time to press can accelerate plus or minus. After modification, press SET to save and exit. If don't press any key, it will save and exit automatically after 10s.

Time control mode: Press▲for 3s to enter into temperature set value modification state ,the upper row PV window display parameter attention “5P”, the lower row SV window display parameter value, press▲ or ▼ to modify, long time to press can accelerate plus or minus. After modification, press SET to save and exit. If don't press any key, it will save and exit automatically after 10s.

★B、 Time set value modification (when it is time &temperature control)

Press▼for 3s to enter into time set value modification state, the upper row PV window display parameter attention “tE”, the lower row SV window display parameter value, press▲ or ▼to modify, long time to press can accelerate plus or minus. After modification, press SET to save and exit. If don't press any key, it will save and exit automatically after 10s.

Inner parameter setting (detailed refer to Sheet5—1)

(1) The second menu

Press SET for 3s to enter into the second menu, the upper row window display parameter code, the lower row window display parameter value, press▲ or ▼to modify, long time to press can accelerate plus or minus. After modification, press SET to save and exit. If don't press any key, it will save and exit automatically after 10s.

(2) The third menu

Press SET +▲to enter into the third menu, setting method is the same as above.

4、 Setting itself

First set the fixed value, and then enter the menu ,set *At* to *on*. At light is on, the controller enter into setting itself state, **set return difference about 0.5~1**, here the controller is ON/OFF control, after three times oscillation, new parameter *P. I. d* can be confirmed and saved, AT light goes out, the controller be reset and enter into the control state.

★6、 Time control function (when it is time& temperature control):

Cut time control side at any time, time will get back to the initial state: When getting time control side, the controller will run according to setting time count down.

Attention

When it is time& temperature control ,it provides multifarious time control method to select, time function detailed refer to inner parameter sheet (Sheet 5—1) ;*not* time function selection part. will not give unnecessary details here.

VII、 Fault Analysis and Clearance

XMT*608 adopt advanced production process, and have the strict test before leaving factory, it improve the reliability of the meter .The usual fault caused by the wrong operation or parameter setting .If you find the fault couldn't be cope with, please record it, and contact with the agent or us. Sheet 7-1 is the usual fault of XMT*608 in the daily application:

Sheet7-1 Common fault disposal